

KENWOOD

KDV-C810
KDV-C820
KDV-C830
KDV-C840
KDV-C860

DVD/CD-MP3 AUTO CHANGER

INSTRUCTION MANUAL

KENWOOD CORPORATION

This player has been designed to play back the DVD software which has been encoded for specific region areas. It cannot play back the DVD software encoded for other region areas than the region areas for which it has been designed.

Take the time to read through this instruction manual.

Familiarity with installation and operation procedures will help you obtain the best performance from your new DVD/CD-MP3 auto changer.

For your records

Record the serial number, found on the back of the unit, in the spaces designated on the warranty card, and in the space provided below. Refer to the model and serial numbers whenever you call upon your KENWOOD dealer for information or service on the product.

Model KDV-C810 Serial number _____

© B64-2291-00 (K/E/M/X/C)
2RR6P10A12900



Contents

| | |
|--|-----------|
| Warning | 3 |
| Safety precautions..... | 4 |
| About Discs..... | 6 |
| Notes on playing MP3 | 7 |
| Glossary..... | 8 |
| Loading discs | 9 |
| Setting the disc | |
| Installing the magazine | |
| Magazine ejection | |
| Operations of remote control .. | 10 |
| Loading and Replacing the battery | |
| Power / Playing Disc | |
| Pausing and Restarting Disc Play (DVD, VCD, CD-DA) | |
| Stopping playback (DVD, VCD, CD-DA) | |
| Disc Search | |
| Track/Chapter Search | |
| Folder Select Mode (MP3) | |
| Forward / Reverse Search (DVD, VCD, CD-DA) | |
| Slow playback (DVD, VCD) | |
| Frame-by-frame playback (DVD, VCD) | |
| Track Scan (VCD, CD-DA) | |
| Repeat Play | |
| Random Play (VCD, CD-DA, MP3) | |
| Direct Disc Search | |
| Direct Track/Chapter Search | |
| GOTO - Direct Search (DVD, VCD, CD-DA) | |
| Using DVD Menu (DVD) | |

| | |
|---|--|
| Using the PBC (VCD) | |
| PBC function On/Off (VCD) | |
| Switching the Viewing Angle (DVD) | |
| Selecting the Sub Title Language (DVD) | |
| Selecting the Audio Language (DVD) | |
| Switching the Vocal sound (DVD, VCD, CD-DA) | |
| Viewing Zoom (DVD, VCD) | |
| Title Information (DVD) | |
| Switching the Time display | |
| List mode | |
| Track List Screen (CD-DA) | |
| File List Screen (MP3) | |

Preferences19

| | |
|--|--|
| Setup mode | |
| Setting the Priority Language | |
| List of language codes | |
| Setting the Audio | |
| Setting the Screen Mode | |
| Setting the Rating Level (parental lock) | |

Operations of center unit25

| | |
|--|--|
| Playing Disc | |
| Pausing and Restarting Disc Play (DVD, VCD, CD-DA) | |
| Fast Forwarding and Reversing (DVD, VCD, CD-DA) | |
| Disc Search | |
| Track/Chapter Search | |
| Folder Select Mode (MP3) | |
| Direct Disc Search (Function of remote) | |
| Direct Track/Chapter Search (Function of | |

| | |
|-------------------------------|--|
| remote) | |
| Track Scan (VCD, CD-DA) | |
| Repeat Play | |
| Random Play (VCD, CD-DA, MP3) | |
| Magazine Random Play | |
| Disc Naming (DNPS) | |

Accessories29

Installation Procedure29

Connecting Wires to Terminals 30

Installation33

Troubleshooting Guide36

Region codes in the world39

Specifications40

▲ Warning

▲ CAUTION

Use of controls or adjustments or performance of procedures other than those specified herein may result in hazardous radiation exposure.

In compliance with Federal Regulations, following are reproductions of labels on, or inside the product relating to laser product safety.

KENWOOD CORPORATION
2967-3, ISHIKAWA-CHO,
HACHIOJI-SHI
TOKYO, JAPAN

KENWOOD CORP. CERTIFIES THIS EQUIPMENT
CONFORMS TO DHHS REGULATIONS NO.21 CFR
1040. 10, CHAPTER 1, SUBCHAPTER J.

Location : Bottom Panel

FCC WARNING

This equipment may generate or use radio frequency energy. Changes or modifications to this equipment may cause harmful interference unless the modifications are expressly approved in the instruction manual. The user could lose the authority to operate this equipment if an unauthorized change or modification is made.

NOTE

This equipment has been tested and found to comply with the limits for a Class B digital device, pursuant to Part 15 of the FCC Rules. These limits are designed to provide reasonable protection against harmful interference in a residential installation. This equipment may cause harmful interference to radio communications, if it is not installed and used in accordance with the instructions. However, there is no guarantee that interference will not occur in a particular installation. If this equipment does cause harmful interference to radio or television reception, which can be determined by turning the equipment off and on, the user is encouraged to try to correct the interference by one or more of the following measures:

- Reorient or relocate the receiving antenna.
- Increase the separation between the equipment and receiver.
- Connect the equipment into an outlet on a circuit different from that to which the receiver is connected.
- Consult the dealer or an experienced radio/TV technician for help.

NOTE

This Class B digital apparatus complies with Canadian ICES-003.

Safety precautions

▲WARNING

To prevent injury or fire, take the following precautions:

- When extending the ignition, battery, or ground wires, make sure to use automotive-grade wires or other wires with a 0.75mm² (AWG18) or more to prevent wire deterioration and damage to the wire coating.
- To prevent a short circuit, never put or leave any metallic objects (such as coins or metal tools) inside the unit.
- If the unit starts to emit smoke or strange smells, turn off the power immediately and consult your Kenwood dealer.

▲CAUTION

To prevent damage to the unit, take the following precautions:

- Make sure to ground the unit to a negative 12V DC power supply.
- Do not open the top or bottom covers of the unit.
- Do not install the unit in a spot exposed to direct sunlight or excessive heat or humidity. Also avoid places with too much dust or the possibility of water splashing.
- When replacing a fuse, only use a new one with the prescribed rating. Using a fuse with the wrong rating may cause your unit to malfunction.
- To prevent a short circuit when replacing a fuse, first disconnect the wiring harness.

- Do not use your own screws. Use only the screws provided. If you use the wrong screws, you could damage the unit.

NOTE

- If you experience problems during installation, consult your Kenwood dealer.
- The illustrations of the display and the panel appearing in this manual are examples used to explain more clearly how the controls are used. Therefore, what appears on the display in the illustrations may differ from what appears on the display on the actual equipment, and some of the illustrations on the display may represent something impossible in actual operation.

The marking of products using lasers (Except for some areas)

CLASS 1 LASER PRODUCT

The label is attached to the chassis/case and says that the component uses laser beams that have been classified as Class 1. It means that the unit is utilizing laser beams that are of a weaker class. There is no danger of hazardous radiation outside the unit.

IMPORTANT INFORMATION

You can enjoy a DVD with this unit alone when connecting it to an external monitor or audio equipment.

Also, you can operate this unit connected to a center unit made by Kenwood to output sound.

A Kenwood-made center unit that can be connected to this unit is called "Center Unit".

About a center unit that can be connected to this unit:

If a center unit (such as CD receivers) has capability for "N" of <"O-N" switch>, this unit can be connected to this unit.

According to the operating instructions of a center unit, the setting of <"O-N" switch> is "N". This unit is, however, exclusive to "N". Therefore, <"O-N" switch> is unnecessary.

If using a separate CD/MD changer switching unit "KCA-S210A", you can connect this unit to a center unit with disc changer control that has no capability for "N".

See the operating instructions attached to KCA-S210A for details of connection.



The functions available and/or information displayable may depend on types of units to which you connect.

Do Not Load 3-in.(8cm) Discs

If you try to load a 3 in.(8cm) Disc with its adapter into the unit, the adapter might separate from the Disc and damage the unit.

Cleaning the Unit

If the front panel is dirty, wipe it clean with a silicon cloth or soft dry cloth with the power off.





Applying spray cleaner directly to the unit may affect its mechanical parts. Wiping the faceplate with a hard cloth or using a volatile liquid such as thinner or alcohol may scratch the surface or erase characters.

Lens Fogging

Right after you turn on the car heater in cold weather, dew or condensation may form on the lens in the Disc player of the unit. Called lens fogging, Discs may be impossible to play. In such a situation, remove the disc and wait for the condensation to evaporate. If the unit still does not operate normally after a while, consult your Kenwood dealer.

This player has been designed to play back the DVD software which has been encoded for specific region areas. It cannot play back the DVD software encoded for other region areas than the region areas for which it has been designed. (page 39)

The KDV-C810 will playback any disc whose region number is  (or ).

The KDV-C820 will playback any disc whose region number is  (or ).

The KDV-C830 will playback any disc whose region number is  (or ).

The KDV-C840 will playback any disc whose region number is  (or ).

The KDV-C860 will playback any disc whose region number is  (or ).

Restrictions due to difference between discs

Some DVD and VCD discs can be played only in certain playback modes according to the intentions of the software producers. As this player plays discs according to their intentions, some functions may not work as intended by you. Please be sure to read the instructions provided with each disc. When an inhibition icon is displayed on the monitor, it indicates that the disc being played is under the restriction as described above.



Inhibition icon

Unplayable discs

This player cannot play back any of the following discs.

- DVD-ROM discs
- DVD-R/DVD-RW/DVD-RAM discs
- SVCD/HQVCD discs
- VSD discs
- CDV discs (Only the audio part can be reproduced.)
- CD-G/CD-EG/CD-EXTRA discs (Only the audio can be reproduced.)
- Photo CD discs (Never attempt to play them.)

This product incorporates copyright protection technology that is protected by method claims of certain U.S. patents and other intellectual property rights owned by Macrovision Corporation and other rights owners. Use of this copyright protection technology must be authorized by Macrovision Corporation, and is intended for home and other limited viewing uses only unless otherwise authorized by Macrovision Corporation. Reverse engineering or disassembly is prohibited.

Manufactured under license from Dolby Laboratories.

"Dolby" and the double-D symbol are trademarks of Dolby Laboratories. Confidential Unpublished Works. ©1992-1997 Dolby Laboratories, Inc. All rights reserved.

"DTS" and "DTS Digital Out" are trademarks of Digital Theater Systems, inc.

About Discs

Handling Discs

- Don't touch the recording surface of the Disc.

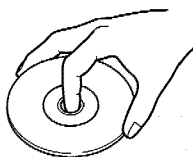

- CD-R and CD-RW are easier to damage than a normal music CD. Use a CD-R or a CD-RW after reading the caution items on the package etc.
- Don't stick tape etc. on the Disc. Also, don't use a Disc with tape stuck on it.

When using a new Disc

If the Disc center hole or outside rim has burrs, use it after removing them with a ball pen etc.

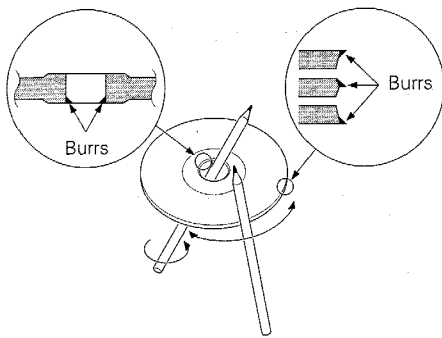

DVD/CD accessories

Don't use disc type accessories.

Disc cleaning

Clean from the center of the disc and move outward.

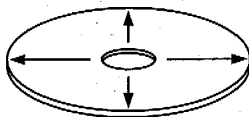

Removing Discs

When removing Discs from this unit pull them out horizontally.

Discs that can't be used

- Discs that aren't round can't be used.

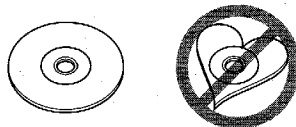

- Discs with coloring on the recording surface or that are dirty can't be used.
- A CD-R or CD-RW that hasn't been finalized can't be played. (For the finalization process refer to your CD-R/CD-RW writing software, and your CD-R/CD-RW recorder instruction manual.)

Disc storage

- Don't place them in direct sunlight (On the seat or dashboard etc.) and where the temperature is high.
- Store Discs in their cases.

Icons on the DVD discs



Indicates the region code where the disc can be played.



Number of voice languages recorded with the audio function. The number in the icon indicates the number of voice languages. (Max. 8 languages)



Number of subtitle languages recorded with the subtitle function. The number in the icon indicates the number of subtitle languages. (Max. 32 languages)



Number of angles provided by the angle function. The number in the icon indicates the number of angles. (Max. 9 angles)

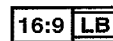

Aspect ratios that can be selected. "LB" stands for Letter Box and "PS" for Pan/Scan. In the example on the left, the 16:9 video can be converted into letter box video.

Notes on playing MP3

This unit can play MP3(MPEG1, 2 Audio Layer 3). Note, however, that the MP3 recording media and formats acceptable are limited. When writing MP3, pay attention to the following restrictions.

Acceptable media

The MP3 recording media acceptable to this unit are CD-ROM, CD-R, and CD-RW.

When using CD-RW, do full format not quick format to prevent malfunction.

Acceptable medium formats

The following formats are available for the media used in this unit. The maximum number of characters used for file name including the delimiter (".") and three-character extension are indicated in parentheses.

- ISO 9660 Level 1 (12 characters)
- ISO 9660 Level 2 (31 characters)
- Joliet (64 characters; up to 19 characters are displayed on this unit)

The media reproducible on this unit has the following limitations:

- Maximum number of directory levels: 8
- Maximum number of files per folder: 255
- Maximum number of characters for folder name: 64 (up to 19 characters are displayed on this unit)
- Maximum number of folders: 50

MP3 written in the formats other than the above may not be successfully played and their file names or folder names are not properly displayed.

Settings for your MP3 encoder and CD writer

When you use your CD writer to record MP3 up to the maximum disc capacity, disable additional writing. For recording on an empty disc up to the maximum capacity at once, check Disc at Once.

Entering file and folder names

When entering file and folder names, use the alphanumeric characters described above only. (ASCII code: 0x20 – 0x7f)

If you use any other character for entry, the file and folder names are not displayed correctly. They may neither be displayed correctly depending on the CD writer used.

The unit recognizes and plays only those MP3 which have the MP3 extension (.MP3).



A file with a name entered with characters not on the code list may not play correctly.

Writing files into a medium

When a medium containing MP3 data is loaded, the unit checks all the data on the medium. If the medium contains a lot of folders or non-MP3 files, therefore, it takes a long time until the unit starts playing MP3.

In addition, it may take time for the unit to move to the next MP3 file or a Track Search or Disc Search may not be performed smoothly.



Loading such a medium may produce loud noise to damage the speakers.

- Do not attempt to play a medium containing a non-MP3 file with the MP3 extension.
The unit mistakes non-MP3 files for MP3 data as long as they have the MP3 extension.
- Do not attempt to play a medium containing non MP3.

MP3 playing order

When selected for play, Track Search, or for Folder Select, files and folders are accessed in the order in which they were written by the CD writer.

Because of this, the order in which they are expected to be played may not match the order in which they are actually played. You may be able to set the order in which MP3 are to be played by writing them onto a medium such as a CD-R with their file names beginning with play sequence numbers such as "01" to "99", depending on your CD writer.

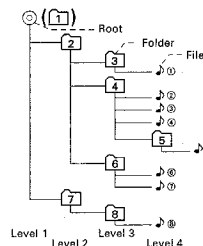

When a Track Search is executed with file 4 being played ...

| Current file number | Operation of the button | |
|---------------------|-------------------------|----------|
| | ◀ Button | ▶ Button |
| 4 | Beginning of file 3 | 5 |

When an Folder select is executed with file 4 being played ...

| Current folder number | Operation of the button | |
|-----------------------|-------------------------|-------------------|
| | DISC-Button | DISC+ Button |
| 1 | 3 2 1 8 | 5 6 7 8 1 |

Glossary

DVD: Digital Versatile Disc

A type of disc which contains recording of audio/video packaged media with high video and audio quality, such as a movie, featuring large recording capacity and digital signal processing capability.

VIDEO CD (VCD)

A type of CD which contains the recording of moving images. It compresses image information by about 1/120 and audio information by about 1/6 and accommodates up to 74 minutes of recording in a disc with the same diameter as ordinary music CD of 12 cm.

Some VCDs do not have the P.B.C. compatibility and are capable of playback only, while some are P.B.C.-compatible and are capable of various special playback control operations. This player can play both of these VCDs.

MPEG: Moving Picture Expert Group (DVD, VCD)

This is an international standard for digital video and audio compression and decompression in media.

Dolby Digital

This is a digital audio compression technology developed by Dolby Laboratories. It is compatible with 5.1-channel surround audio as well as normal stereo (2-channel) audio and can accommodate a large amount of audio data efficiently in a disc.

DTS

Name of a digital surround system developed by Digital Theater Systems, Inc.

MENU/TOP MENU (DVD)

Some DVDs display more than one title in a screen. This screen is referred to as the title menu.

The DVD menu is the item display (menu screen) for use in setting operations. The DVD menu can be recalled any time during playback to perform settings according to the current software, including the audio switching between Dolby Digital and PCM, switching of language used in the subtitles and spoken voice.

Subtitles (DVD)

Some DVD discs contains the recording of more than one subtitle language. This player allow you to select one of the recorded subtitle languages during playback.

Title number (DVD)

The title is the largest unit of video and audio recorded in a DVD. It usually corresponds to a single movie of video software or an album (sometimes a piece of music) of music software. The numbers assigned to individual titles are referred to as the title numbers.

Chapter number (DVD)

The chapter is a section of video and audio recorded in a DVD. A title is composed of several chapters. The numbers assigned to individual chapters are referred to as the chapter numbers.

Track number (CD, VCD)

A track is also a section of video and audio recorded in a disc. The numbers assigned to individual tracks are referred to as the track numbers.

With most of music Discs, a track is assigned to a piece of music. However, with a VCD, the sections of the contents do not always correspond to the assigned tracks.

As (special) playback functions such as skipping and programming of ordinary Discs are based on track number data, such playback functions are sometimes impossible with some VCDs.

P.B.C.: Play-Back Control (VCD)

When a VIDEO CD carries "Play Back Control capable" or similar message on the disc or jacket, desired scenes and information can be played back in an interactive manner using a hierarchical structure while viewing the menu screens displayed on the TV screen.

Loading discs

Setting the disc

- 1 Make sure the disc magazine is the right way up with the "DVD"/"disc" logo on the top. Pull the tray out by the projection.

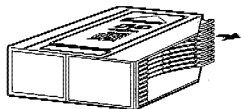

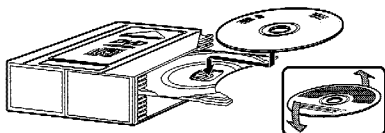

- 2 Set a disc on the tray with the recording face upward. (The label face is downward.)

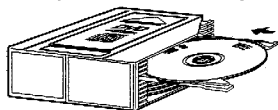

 8-cm discs cannot be used. If an 8-cm disc adapter is used, the disc cannot be ejected.

- 3 Insert the tray into the disc magazine until it locks.



 The discs are numbered from the top from 1 to 10.

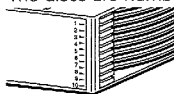

Installing the magazine

- 1 Open the DVD/CD changer door.

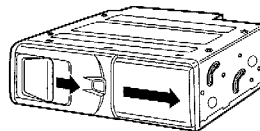

- 2 Insert the magazine into the DVD/CD changer until it clicks.

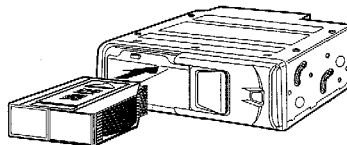

- 3 Close the DVD/CD changer door.

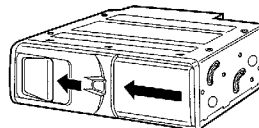

Magazine ejection

- 1 Open the DVD/CD changer door.

- 2 Press the [EJECT] button.

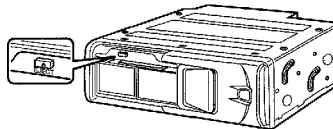

- 3 Close the DVD/CD changer door.

Operations of remote control

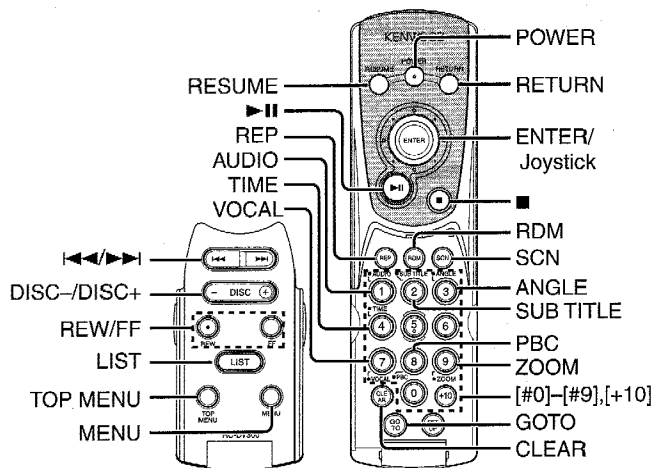

<OSD of DVD/VCD>

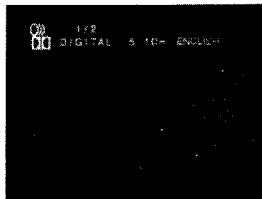

- : Angle indicator
- : Language for subtitle indicator
- : Language for voice indicator
- OSD : On Screen Display

<OSD of CD-DA>

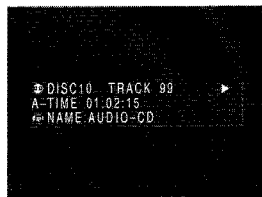

<OSD of MP3>

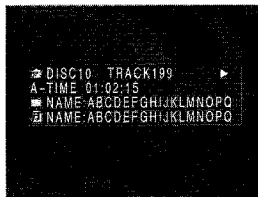

Loading and Replacing the battery

Use two "AAA"-size batteries.

Insert the batteries with the + and - poles aligned properly, following the illustration inside the case.

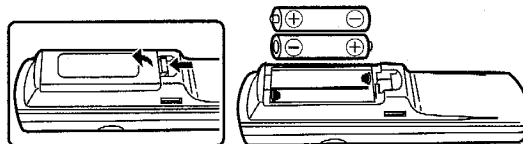

⚠ WARNING

Store unused batteries out of the reach of children. Contact a doctor immediately if the battery is accidentally swallowed.



Do not set the remote on hot places such as above the dashboard.



- When the remote controllable distance becomes short, replace both of the batteries with new ones.
- A portion of the operations may not be possible, depending on the unit that is connected.

Power / Playing Disc

Turning ON the Power

Press the [POWER] button.

Turning OFF the Power

Press the [POWER] button.



You cannot view video pictures whilst the vehicle is moving. To enjoy video pictures, find a safe place to park and engage the parking brake. (Video output for front seats)



It takes time for the unit to check each medium to see if it contains any MP3 file before it starts playing the medium.



Select the source mode of this unit on the center unit to operate this unit linked with the center unit.

- Before selecting a source of this unit on the center unit
 - Turn on/off the power on the remote controller.
- After selecting a source of this unit on the center unit
 - Select the source mode of this unit to turn it on.
 - Select the other modes to turn off this unit.
 - Cannot turn off this unit on the remote controller.

Pausing and Restarting Disc Play (DVD, VCD, CD-DA)

Press the **[▶||]** button to make the disc pause.
 Press the **[▶||]** button again to start play again.



- The following operation may not be available with certain discs.
- For MP3, Refer to <Folder Select Mode>. (page 11)

Stopping playback (DVD, VCD, CD-DA)

Press the **[■]** button.
 Press the button once during playback stops it and the position where it is stopped is stored in memory.



- Press **[▶||]** under this condition to resume the play.
- No operation is possible depending on disks.
- For MP3, Refer to <Folder Select Mode>. (page 11)

Press the **[■]** button.
 Press the button twice to cancel playback.

Disc Search

Selecting the disc you want to hear.
 Press the **[DISC-]** or **[DISC+]** button.

Track/Chapter Search

Press the **[◀◀]** or **[▶▶]** button.

| Disc | Search |
|---------------------|-------------------------|
| DVD | Searching for a chapter |
| VCD[PBC ON] | Searching for a select |
| VCD[PBC OFF], CD-DA | Searching for a track |
| MP3 | Searching for a file |

Folder Select Mode (MP3)

Selecting the folder you want to hear.

1 Stopping play and Folder Select mode

Press the **[▶||]** or **[■]** button.

2 Selecting the desired folder

Press the **[DISC-]** or **[DISC+]** button.

3 Decide the folder to play

Press the **[▶||]** button.

The Folder Select mode releases, and the MP3 in the folder being displayed is played.

Operations of remote control

Forward / Reverse Search (DVD, VCD, CD-DA)

Forward search

Press the [FF] button.

Reverse search

Press the [REW] button.



- Each time the button is pressed the Search speed switches as shown below.

| Setting | Display |
|---------|----------------------|
| 2 times | "---<<< / >>>--- |
| 4 times | "--<<<< / >>>>--- |
| 6 times | "-<<<<< / >>>>>--- |
| 8 times | "-<<<<<< / >>>>>>--- |

- Audio output of DVDs and video CDs is disabled during fast-forward and fast-rewind. Audio output of audio CDs is disabled at the 8x-speed operation.

Canceling Fast Forwarding / Reversing

Press the [▶II] button.

Slow playback (DVD, VCD)

1 Pausing

Press the [▶II] button.

2 Forward slow playback

Press the [FF] button.

Reverse slow playback

Press the [REW] button.



- Each time the button is pressed the Search speed switches as shown below.

| Setting | Display |
|-----------|--------------------------|
| 1/6 times | "--<<<<<< / >>>>>>--- |
| 1/4 times | "-<<<<<<< / >>>>>>>--- |
| 1/2 times | "-<<<<<<<< / >>>>>>>>--- |

- Slow rewinding play is disabled for VCD.

- While a VCD is played with the PBC function disabled, a track change releases the slow playback.

Canceling the slow playback

Press the [▶II] button.

Frame-by-frame playback (DVD, VCD)

1 Pausing

Press the [▶II] button.

2 Frame-by-frame playback

Press the [◀◀] or [▶▶] button.

Canceling the frame-by-frame playback

Press the [▶II] button.

Track Scan (VCD, CD-DA)

Playing the first part of each song on the disc you are listening to and searching for the song you want to listen to. (VCD: When the PBC function is set to [OFF], page 14)

1 Start Track Scan

Press the [SCN] button.

"SCAN" is displayed. Scan starts from the first track.

2 Release it when the song you want to listen to is played

Press the [SCN] or [▶II] button.

Repeat Play

(VCD: When the PBC function is set to [OFF], page 14)

Press the [REP] button.

Each time the button is pressed the Repeat Play switches as shown below.

DVD:

| <u>Repeat play</u> | <u>Display/Indicator</u> |
|--------------------|--------------------------|
| Chapter Repeat | "CHAPTER REPEAT"/"CREP" |
| Title Repeat | "TITLE REPEAT"/"TREP" |
| OFF | "REPEAT OFF"/- |

VCD[PBC OFF], CD-DA:

| <u>Repeat play</u> | <u>Display/Indicator</u> |
|--------------------|--------------------------|
| Track Repeat | "REPEAT"/"REP" |
| OFF | "REPEAT OFF"/- |

MP3:

| <u>Repeat play</u> | <u>Display/Indicator</u> |
|--------------------|--------------------------|
| File Repeat | "FILE REPEAT"/"REP" |
| Folder Repeat | "FOLDER REPEAT"/"FREP" |
| OFF | "REPEAT OFF"/- |

Random Play (VCD, CD-DA, MP3)

Play all the songs on the disc or MP3 folder in random order.
(VCD: When the PBC function is set to [OFF], page 14)

Press the [RDM] button.

Each time the button is pressed Random Play turns ON or OFF.
When it's ON, "RANDOM"/"RDM" is displayed.



- When the [▶▶] button is pressed, the next song select starts.
- When the [◀◀] button is pressed, the beginning of the current song.

Direct Disc Search

Doing Disc Search by entering the disc number.

1 Enter List Screen

Press the [LIST] button.

2 Enter the disc number

Press the number buttons.

3 Do Disc Search

Press the [DISC+] or [DISC-] button.

Clear the Disc number

Press the [CLEAR] button.

Direct Track/Chapter Search

Doing Track/Chapter Search by entering the track/chapter number.

1 Enter List Screen

Press the [LIST] button.

2 Enter the track/Chapter number

Press the number buttons.



Press [+10] button to input two digits or more.

3 Do Track/Chapter Search

Press the [◀◀] or [▶▶] button.

Clear the Track/Chapter number

Press the [CLEAR] button.

Operations of remote control

GOTO - Direct Search (DVD, VCD, CD-DA)

1 Enter GOTO mode

Press the [GOTO] button.

For DVDs, specify the title/chapter number or the elapsed time of the title.

For VCD[PBC OFF] and CD-DA, specify the elapsed time of the disc.

2 Select Search mode (DVD only)

Press the [GOTO] button.

Each time the button is pressed the Search mode switches as shown below.

| Search mode | Display |
|----------------------|----------------------|
| Title/Chapter Search | "T. **/ ** C. **/**" |
| Time Search | "TIME _ : _ : _" |



You can switch the title input from/to the chapter input by operating the joystick from left side to right side in the title/chapter input mode.

3 Enter the number

Press the number buttons.



Example: In case of Chapter 13 of a DVD

"T02/05 C005/030" : ② ③

Example: In case of 1 hour 23 min. 45 sec. of a CD-DA

"GOTO _ : _ : _" : ① ② ③ ④ ⑤

4 Do Search

Press the [ENTER] button.

Using DVD Menu (DVD)

Available in DVDs with title menus/root menus.

1 Enter Title Menu mode

Press the [MENU] button.

"DVD MENU" is displayed.

Enter Top Menu (root menu) mode

Press the [TOP MENU] button.

"TITLE MENU" is displayed.

2 Selecting the menu item

Move the Joystick or press the number buttons.

3 Setting the menu item

Press the [ENTER] button.



See your disc's operating instructions for information on the menu operation.

Canceling the Menu mode

Press the [RESUME] button.

Using the PBC (VCD)

Available for video CDs with playback control record. (VCD:
When the PBC function is set to [ON], page 14)

1 Selecting the menu item

Move the Joystick or press the number buttons.

2 Setting the menu item

Press the [ENTER] button.



See your disc's operating instructions for information on the PBC operation.

PBC function On/Off (VCD)

You can determine whether to use the PBC function for video CDs with playback control record.

Press the [PBC] button for at least 1 second.

Each time the button is pressed PBC function turns ON or OFF.

 This function cannot be used during the List Mode. (page 17)

Switching the Viewing Angle (DVD)

Press the [ANGLE] button for at least 1 second.

Each time you press the button to switch viewing angle.

Selecting the Sub Title Language (DVD)

Press the [SUB TITLE] button for at least 1 second.

Each time you press the button to change the sub title language.

 This function cannot be used during the List Mode. (page 17)

Selecting the Audio Language (DVD)

Press the [AUDIO] button for at least 1 second.

Each time you press the button to change the voice language.

Switching the Vocal sound (DVD, VCD, CD-DA)

Press the [VOCAL] button for at least 1 second.

Each time the button is pressed the vocal sound switches.

KARAOKE DVD

| <u>Display</u> | <u>Setting</u> |
|----------------|----------------|
| "LEFT VOCAL" | Left vocal |
| "RIGHT VOCAL" | Right vocal |

| | |
|--------------|-----------------|
| "BOTH VOCAL" | Both vocal |
| "MIX VOCAL" | Mix vocal |
| "NO VOCAL" | Vocal sound off |

 This function cannot be used during the List Mode. (page 17)

VCD/CD-DA

| <u>Display/Indicator</u> | <u>Setting</u> |
|--------------------------|------------------------|
| "MONO LEFT"/"LchONLY" | Monaural Left (L / L) |
| "MONO RIGHT"/"RchONLY" | Monaural Right (R / R) |
| "STEREO"/"LR BOTH" | Stereo (L / R) |

Viewing Zoom (DVD, VCD)

Zooming the image

Press the [ZOOM] button for at least 1 second.

Each time the button is pressed the image switches between zoom ("X1.5", "X2", "X4") and normal ("OFF").

 This function cannot be used during the List Mode. (page 17)

Scrolling the image

Move the Joystick.

The zoom point is scrolled as the joystick moves.

Operations of remote control

Title Information (DVD)

This shows the information on your disc/title.

1 Enter Title Information

Press the [PBC] button for at least 1 second.



This function cannot be used during the List Mode. (page 17)



2 Select Title

Move the Joystick to left or right side.



Press the [FF] or [REW] button to switch a title quickly.

Canceling the title information

Press the [PBC] button for at least 1 second.

Switching the Time display

Press the [TIME] button for at least 1 second.

Each time the button is pressed the display switches as shown below.



The chapter time is not displayed depending on software.

In OSD screen

DVD

| Information | Display |
|-------------------------|-------------------------|
| Title time | "TITLE#### CHAPTER####" |
| Remaining time of title | "TITLE REMAIN" |
| Chapter time | "CHAPTER ELAPSED" |
| OFF | - |

VCD[PBC ON]

| Information | Display |
|-------------|------------------|
| Track Time | "SINGLE ELAPSED" |
| OFF | "OFF" |

VCD[PBC OFF]

| Information | Display |
|-------------------------------|------------------|
| Track Time | "SINGLE ELAPSED" |
| Disc time | "TOTAL ELAPSED" |
| Remaining time of entire disc | "TOTAL REMAIN" |
| OFF | "OFF" |

CD-DA

| Information | Display/Indicator |
|-------------------------------|---------------------------|
| Track Time | "SINGLE ELAPSED"/"P-TIME" |
| Disc time | "TOTAL ELAPSED"/"A-TIME" |
| Remaining time of entire disc | "TOTAL REMAIN"/"R-TIME" |

MP3

| Information | Display/Indicator |
|------------------------|-------------------------|
| File Time | "FILE ELAPSED"/"P-TIME" |
| Remaining time of file | "FILE REMAIN"/"R-TIME" |

In List screen

DVD

| Information | Indicator |
|-------------------------|------------------|
| Title time | "A-TIME" |
| Remaining time of title | "R-TIME" |
| Chapter time | "P-TIME" |

VCD[PBC ON]

| Information | Indicator |
|--------------------|------------------|
| Track Time | "P-TIME" |

VCD[PBC OFF], CD-DA

| Information | Indicator |
|-------------------------------|------------------|
| Track Time | "P-TIME" |
| Disc time | "A-TIME" |
| Remaining time of entire disc | "R-TIME" |

MP3

| Information | Display |
|------------------------|----------------|
| File Time | "P-TIME" |
| Remaining time of file | "R-TIME" |

List mode

1 Enter List Screen

Press the [LIST] button.

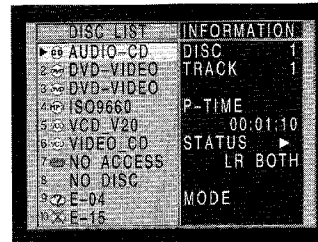

2 Select the Disc

Move the Joystick to front or back side.

Press the [ENTER] button.

| Disc | Select items |
|-------------|---|
| DVD | The DVD will start playing. |
| VCD | The VCD will start playing. |
| CD-DA | The CD-DA will start playing. Refer to the Track List Screen. |
| MP3 | The MP3 will start playing. Refer to the File List Screen. |

Canceling the List mode

Press the [LIST] button.

Operations of remote control

Track List Screen (CD-DA)

1 Starting CD-DA

Refer to the List mode.

2 Switching to the track list screen

Press the [ENTER] button.

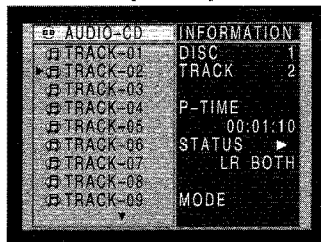

3 Select the track list

Move the Joystick to left or right side.

4 Select the track

Move the Joystick to front or back side.

Press the [ENTER] button.

Scrolling the track list

1 Stopping playback

Press the [■] button.

2 Press the [◀] or [▶] button.

Returning to the List mode

1 Select the disc title

Move the Joystick to left or right side.

2 Returning to the list screen

Press the [ENTER] button.

File List Screen (MP3)

1 Starting MP3

Refer to the List mode.

2 Switching to the file/folder list screen

Press the [ENTER] button.

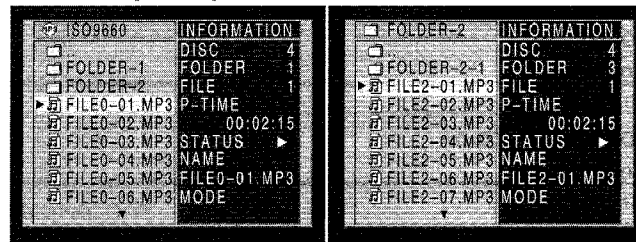

3 Select the file/folder list

Move the Joystick to left or right side.

4 Select the file/folder

Move the Joystick to front or back side.

Press the [ENTER] button.

Display

Select items

| | |
|----------|----------------------------------|
| ▶ File | The MP3 file will start playing. |
| ▶ Folder | Move to a folder. |
| ▶ .. | Move to an upper-level folder. |

Scrolling the file/folder list

1 Stopping playback

Press the [■] button.

2 Press the [◀] or [▶] button.

Returning to the List mode

1 Select the disc/folder title

Move the Joystick to left or right side.



Preferences

2 Returning to the list screen

Press the [ENTER] button.

Display

Select items

| | |
|--|--------------------------------|
|  Disc | Returning to the list screen. |
|  Folder | Move to an upper-level folder. |

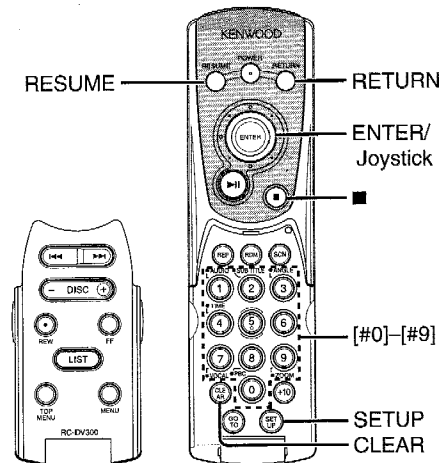

<SETUP screen>

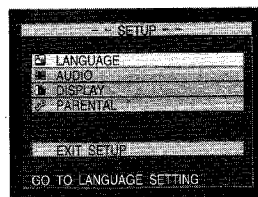

Preferences

Setup mode

1 Stopping playback

Press the [■] button.

2 Enter Setup mode

Press the [SETUP] button.

3 Select the setup item

Move the Joystick.

Press the [ENTER] button.

Display

"LANGUAGE" page 20

"AUDIO" page 23

"DISPLAY" page 24

"PARENTAL" page 24

4 Exit Setup mode

Select "EXIT SETUP" and press the [ENTER] button.

Canceling the Setup mode

Press the [SETUP] or [RESUME] button.

Setting the Priority Language

1 Select "LANGUAGE" mode

See <Setup mode> to select "LANGUAGE".

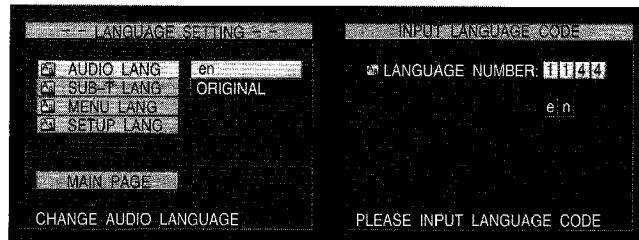

2 Select the language item

Move the joystick to select an item.

Press the [ENTER] button.

"AUDIO LANG"

Set the audio language produced from the speakers.

| Display | Setting |
|--------------|---|
| Example "en" | The display switches to the language number input screen. |
| "ORIGINAL" | The original language of a disc. |

"SUB-T LANG"

Set the language of the subtitles displayed on the screen.

| Display | Setting |
|--------------|---|
| Example "en" | The display switches to the language number input screen. |
| "ORIGINAL" | The original language of a disc. |
| "OFF" | No subtitle is displayed |

"MENU LANG"

Set the language used for the menus (title menu, etc.).

| Display | Setting |
|--------------|---|
| Example "en" | The display switches to the language number input screen. |
| "ORIGINAL" | The original language of a disc. |

"SETUP LANG"

Set the setup, message or other display languages.

| Display | Setting |
|----------------|------------------|
| "ENGLISH" | Set the English |
| "日本語" | Set the Japanese |

3 Select the language (Language number input screen)

Press the number buttons.

See "List of language codes" to input a 4-digit code.

Press the [ENTER] button.

Returning to the Previous screen

Press the [RETURN] button.

Preferences

List of language codes

| Code | Language | Code | Language |
|------|---------------------|------|--------------------|
| 1027 | aa Afar | 1028 | ab Abkhazian |
| 1032 | af Afrikaans | 1039 | am Amharic |
| 1044 | ar Arabic | 1045 | as Assamese |
| 1051 | ay Aymara | 1052 | az Azerbaijani |
| 1053 | ba Bashkir | 1057 | be Byelorussian |
| 1059 | bg Bulgarian | 1060 | bh Bihari |
| 1061 | bi Bislama | 1066 | bn Bengali, Bangla |
| 1067 | bo Tibetan | 1070 | br Breton |
| 1079 | ca Catalan | 1093 | co Corsican |
| 1097 | cs Czech | 1103 | cy Welsh |
| 1105 | da Danish | 1109 | de German |
| 1130 | dz Bhutani | 1142 | el Greek |
| 1144 | en English | 1145 | eo Esperanto |
| 1149 | es Spanish | 1150 | et Estonian |
| 1151 | eu Basque | 1157 | fa Persian |
| 1165 | fi Finnish | 1166 | fj Fiji |
| 1171 | fo Faeroese | 1174 | fr French |
| 1181 | fy Frisian | 1183 | ga Irish |
| 1186 | gd Scots Gaelic | 1194 | gl Galician |
| 1196 | gn Guarani | 1203 | gu Gujarati |
| 1209 | ha Hausa | 1217 | hi Hindi |
| 1226 | hr Croatian | 1229 | hu Hungarian |
| 1233 | hy Armenian | 1235 | ia Interlingua |
| 1239 | ie Interlingue | 1245 | ik Inupiak |
| 1248 | in Indonesian | 1253 | is Icelandic |
| 1254 | it Italian | 1257 | iw Hebrew |
| 1261 | ja Japanese | 1269 | ji Yiddish |
| 1283 | jw Javanese | 1287 | ka Georgian |
| 1297 | kk Kazakh | 1298 | kl Greenlandic |
| 1299 | km Cambodian | 1300 | kn Kannada |
| 1301 | ko Korean | 1305 | ks Kashmiri |
| 1307 | ku Kurdish | 1311 | ky Kirghiz |
| 1313 | la Latin | 1326 | ln Lingala |
| 1327 | lo Laothian | 1332 | lt Lithuanian |
| 1334 | lv Latvian, Lettish | 1345 | mg Malagasy |
| 1347 | mi Maori | 1349 | mk Macedonian |
| 1350 | ml Malayalam | 1352 | mn Mongolian |
| 1353 | mo Moldavian | 1356 | mr Marathi |
| 1357 | ms Malay | 1358 | mt Maltese |
| 1363 | my Burmese | 1365 | na Nauru |
| 1369 | ne Nepali | 1376 | nl Dutch |
| 1379 | no Norwegian | 1393 | oc Occitan |
| 1403 | om (Afan) Oromo | 1408 | or Oriya |
| 1417 | pa Punjabi | 1428 | pl Polish |
| 1435 | ps Pashto, Pushto | 1436 | pt Portuguese |
| 1463 | qu Quechua | 1481 | rm Rhaeto-Romance |
| 1482 | rn Kirundi | 1483 | ro Romanian |
| 1489 | ru Russian | 1491 | rw Kinyarwanda |
| 1495 | sa Sanskrit | 1498 | sd Sindhi |
| 1501 | sg Sangro | 1502 | sh Serbo-Croatian |
| 1503 | si Singhalese | 1505 | sk Slovak |
| 1506 | sl Slovenian | 1507 | sm Samoan |
| 1508 | sn Shona | 1509 | so Somali |
| 1511 | sq Albanian | 1512 | sr Serbian |
| 1513 | ss Siswati | 1514 | st Sesotho |
| 1515 | su Sundanese | 1516 | sv Swedish |
| 1517 | sw Swahili | 1521 | ta Tamil |
| 1525 | te Tegulu | 1527 | tg Tajik |
| 1528 | th Thai | 1529 | ti Tigrinya |
| 1531 | tk Turkmen | 1532 | tl Tagalog |
| 1534 | tn Setswana | 1535 | to Tonga |
| 1538 | tr Turkish | 1539 | ts Tsonga |
| 1540 | tt Tatar | 1543 | tw Twi |
| 1557 | uk Ukrainian | 1564 | ur Urdu |
| 1572 | uz Uzbek | 1581 | vi Vietnamese |

| | | | | | |
|------|----|---------|------|----|--------|
| 1587 | vo | Volapuk | 1613 | wo | Wolof |
| 1632 | xh | Xhosa | 1665 | yo | Yoruba |
| 1684 | zh | Chinese | 1697 | zu | Zulu |

"OPT-PCM" If connecting through digital audio equipment without any Dolby Digital or DTS decoder,



If connecting with digital audio equipment without any Dolby Digital or DTS decoder, select "OPT-PCM" for the setting. If the setting is "OPT-RAW", it may cause a large sound or noise, which can result in failure.



- "ANALOG": To output analog signal but no digital signal.
- "OPT-RAW": To output bit-stream signal if playing with Dolby Digital or DTS. If playing with MPEG or linear PCM, you obtain the output with PCM. No analog signal is output.
- "OPT-PCM": To output with PCM if playing with Dolby Digital, MPEG or linear PCM. If playing with DTS, you obtain no output. No analog signal is output.

Setting the Audio

1 Select "AUDIO" mode

See <Setup mode> to select "AUDIO".

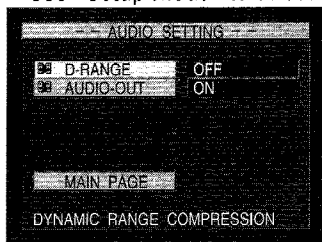

2 Select the audio

Move the joystick to select an item.

Press the [ENTER] button.

"D-RANGE"

| Display | Setting |
|---------|--|
| "OFF" | For the regular sound |
| "ON" | For more powerful sound at regular volumes |

"AUDIO-OUT"

Setting digital output type.

| Display | Setting |
|-----------|--|
| "ANALOG" | If connecting through a center unit or RCA cable, |
| "OPT-RAW" | If connecting through a Dolby Digital or DTS decoder |

Preferences

Setting the Screen Mode

Use the procedure described below to set the output screen.

1 Select "DISPLAY" mode

See <Setup mode> to select "DISPLAY".

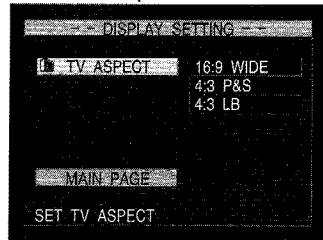

2 Select the "TV ASPECT"

Move the joystick to select an item.
Press the [ENTER] button.

| Display | Setting |
|-------------|--|
| "16:9 WIDE" | Set the picture mode of the wide-screen monitor to "FULL" |
| "4:3 P&S" | Wide-screen software with pan & scan specification is played in a panned & scanned screen (with the left and right sides cut off). |
| "4:3 LB" | Wide-screen software with pan & scan specification is played in a letter box screen (with black stripes on the top and bottom). |

Setting the Rating Level (parental lock)

Use this function to restrict the viewing of movies to children of appropriate age levels only.

1 Select "PARENTAL" mode

See <Setup mode> to select "PARENTAL".

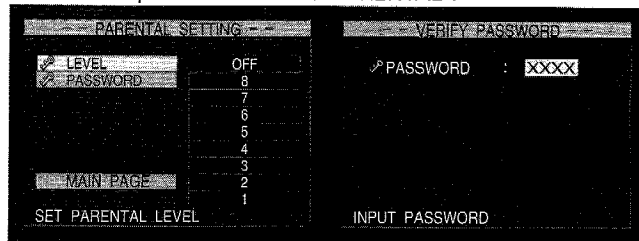

2 Setting the "LEVEL"(Parental Level)

Move the joystick to select an item.
Press the [ENTER] button.

| Display | Setting |
|-----------|---|
| "OFF" | Canceling the parental lock. |
| "8" | Plays any software (including adult-, general- and children-oriented). |
| "7" - "2" | Plays general- and children-oriented DVD software. Restricts playback of adult-oriented DVD software. |
| "1" | Plays children-oriented software. Restricts playback of adult and general-oriented DVD software. |



Parental level varies with the discs.

3 Enter the password

Press the number buttons.

Enter your password (4-digit). Input numbers are displayed "X".
Press the [ENTER] button.



- If you enter the wrong number, press the [CLEAR] button. The entered number is cleared.
- The password's initial value is 0000.
- Pressing the Reset button erases the password.

To change the password

Select "PASSWORD" and press the [ENTER] button.

Operations of center unit

| Display | Setting |
|---------------|--|
| "CURRENT PWD" | To enter your current password correctly |
| "NEW PWD" | To enter a new password |
| "REENTER PWD" | To enter the new password again for confirmation |



- Some discs may request that you change the rating level set in the default settings during playback. In this case, the rating level setup screen is displayed, if you do not input the correct password either playback does not continue or a picture for a different rating level is played.
- Write down the password on a piece of paper and store the piece of paper somewhere in case you forget it.
- On undated DVDs, playback will not be restricted even if the rating level is set.
- Once set, this rating level remains in memory until changed. To enable the play of discs of higher rating levels or to cancel the parental lock, the setting must be changed.
- Not all DVDs provide a Parental Lock feature. If you are unsure about a DVD, play it first to confirm. Do not leave DVDs accessible to young children for whom you deem them inappropriate.

Button Name and Functions of Center unit

[SRC]: Selecting the Source
[▶||]: Pause and Play
[DISC-]: Making a Reverse Disc Search (Album Search)
[DISC+]: Making a Forward Disc Search (Album Search)
[◀◀]: Making a Reverse Track Search
[▶▶]: Making a Forward Track Search
[SCN]/[SCAN]: Track Scan
[REP]: Track Repeat (Track/Disc(Album) Repeat)
[D-REP]: Disc Repeat (Album Repeat)
[RDM]: Random Play



Some functions may be disabled depending on center units. Also see operation manual of your center unit.

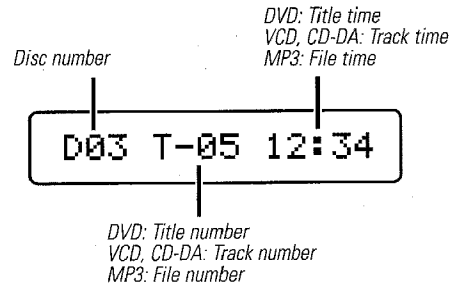

Operations of center unit

Playing Disc

Press the [SRC] button.

Select the "CD-CH"/"DISC"/"AUX" display.



You cannot view video pictures whilst the vehicle is moving. To enjoy video pictures, find a safe place to park and engage the parking brake. (Video output for front seats)



- It takes time for the unit to check each medium to see if it contains any MP3 file before it starts playing the medium.
- File No. may not be shown depending on center units to be connected if the number is 100 or 200.



Select the source mode of this unit on the center unit to operate this unit linked with the center unit.

- Before selecting a source of this unit on the center unit
 - Turn on/off the power on the remote controller.
- After selecting a source of this unit on the center unit
 - Select the source mode of this unit to turn it on.
 - Select the other modes to turn off this unit.
 - Cannot turn off this unit on the remote controller.

Pausing and Restarting Disc Play (DVD, VCD, CD-DA)

Press the [▶II] button to make the disc pause.

Press the [▶II] button again to start play again.



- The following operation may not be available with certain discs.
- For MP3, Refer to <Folder Select Mode>. (page 26)

Fast Forwarding and Reversing (DVD, VCD, CD-DA)

Fast Forwarding

Hold down on the [▶▶] button.

Release your finger to play the disc at that point.

Reversing

Hold down on the [◀◀] button.

Release your finger to play the disc at that point.



Search is carried out at the 6x speed.

Disc Search

Selecting the disc you want to hear.

Press the [DISC-] or [DISC+] button.

Track/Chapter Search

Press the [◀◀] or [▶▶] button.

| Disc | Search |
|---------------------|-------------------------|
| DVD | Searching for a chapter |
| VCD[PBC ON] | Searching for a select |
| VCD[PBC OFF], CD-DA | Searching for a track |
| MP3 | Searching for a file |

Folder Select Mode (MP3)

Selecting the folder you want to hear.

1 Stopping play and Folder Select mode

Press the [▶II] button.



File No. display changes to Folder No. display during the Folder select mode.

2 Selecting the folder

Press the [DISC-] or [DISC+] button.

3 Decide the folder to play

Press the [▶||] button.

The Folder Select mode releases, and the MP3 in the folder being displayed is played.

Direct Disc Search (Function of remote)

Doing Disc Search by entering the disc number.

1 Enter the disc number

Press the number buttons on the remote.

 Input "0" to select disc 10.

2 Do Disc Search

Press the [DISC+] or [DISC-] button.

Canceling Direct Disc Search

Press the [▶||] button.

Direct Track/Chapter Search (Function of remote)

Doing Track/Chapter Search by entering the track/chapter number.

1 Enter the track/Chapter number

Press the number buttons on the remote.

 Direct Track/Chapter Search is enabled for up to 99.

2 Do Track/Chapter Search

Press the [◀◀] or [▶▶] button.

Canceling Direct Track/Chapter Search

Press the [▶||] button.

Track Scan (VCD, CD-DA)

Playing the first part of each song on the disc you are listening to and searching for the song you want to listen to.
(VCD: When the PBC function is set to [OFF], page 14)

1 Start Track Scan

Press the [SCN] button.

Scan starts from the first track.

2 Release it when the song you want to listen to is played

Press the [SCN] or [▶||] button.

Operations of center unit

Repeat Play

(VCD: When the PBC function is set to [OFF], page 14)

Press the [REP] or [D-REP] button.

Each time the button is pressed the Repeat Play switches as shown below.

Track Repeat ON:

| Disc | Repeat play |
|--------------|----------------|
| DVD | Chapter Repeat |
| VCD[PBC OFF] | Track Repeat |
| CD-DA | Track Repeat |
| MP3 | File Repeat |

Disc Repeat ON:

| Disc | Repeat play |
|------|---------------|
| DVD | Title Repeat |
| MP3 | Folder Repeat |

Repeat OFF:

| Disc | Repeat play |
|--------------|-------------|
| DVD | Repeat Off |
| VCD[PBC OFF] | Repeat Off |
| CD-DA | Repeat Off |
| MP3 | Repeat Off |



Random Play (VCD, CD-DA, MP3)

Play all the songs on the disc or MP3 folder in random order.

(VCD: When the PBC function is set to [OFF], page 14)

Press the [RDM] button.

Each time the button is pressed Random Play turns ON or OFF.

-  • When the [▶▶] button is pressed, the next song select starts.
-  • When the [◀◀] button is pressed, the beginning of the current

song.

Magazine Random Play



Magazine Random Play is disabled in this unit.

Disc Naming (DNPS)













The disc name preset function can register names of up to 29 discs using up to 12 characters for each disc name.

The availability of this function as well as the number of discs which can be registered using this function and the number of usable characters may be variable depending on the control unit in use.

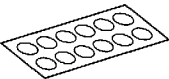

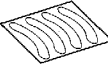
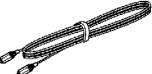
DVD and MP3 recorded media allows you to register a single media name only.

Accessories

| External view | Number of items | External view | Number of items |
|--|-----------------------|---|-----------------------|
| ①  |1 | ⑧  |1 |
| ②  |1 | ⑨  |4 |
| ③  |4 | ⑩  |1 |
| ④  |6 | ⑪  |1 |
| ⑤  |1 | ⑫  |1 |
| ⑥  |1 | ⑬  |1 |
| ⑦  |1 | ⑭  |1 |
| | | ⑮  |1 |

 The use of any accessories except for those provided might result in damage to the unit. Make sure only to use the accessories shipped with the unit, as shown above.

Installation Procedure

1. To prevent short circuits, remove the key from the ignition and disconnect the \ominus terminal of the battery.
2. Make the proper input and output wire connections for each unit.
3. Connect the wire on the wiring harness.
4. Install the unit in your car.
5. Reconnect the \ominus terminal of the battery.

WARNING

If you connect the ignition wire (red) and the battery wire (yellow) to the car chassis (ground), you may cause a short circuit, that in turn may start a fire. Always connect those wires to the power source running through the fuse box.

CAUTION

- If your car is not prepared for this special connection-system, consult your Kenwood dealer.
- Make sure that all wire connections are securely made by inserting jacks until they lock completely.
- If your vehicle's ignition does not have an ACC position, or if the ignition wire is connected to a power source with constant voltage such as a battery wire, the power will not be linked with the ignition (i.e., it will not turn on and off along with the ignition). If you want to link the unit's power with the ignition, connect the ignition wire to a power source that can be turned on and off with the ignition key.
- If the fuse blows, first make sure that the wires have not caused a short circuit, then replace the old fuse with one with the same rating.
- Insulate unconnected wires with vinyl tape or other similar material. To prevent short circuits, also do not remove the caps on the ends of the unconnected wires or the terminals.
- After the unit is installed, check whether the brake lamps, indicators, wipers, etc. on the car are working properly.

Connecting Wires to Terminals

■ Power wire connection

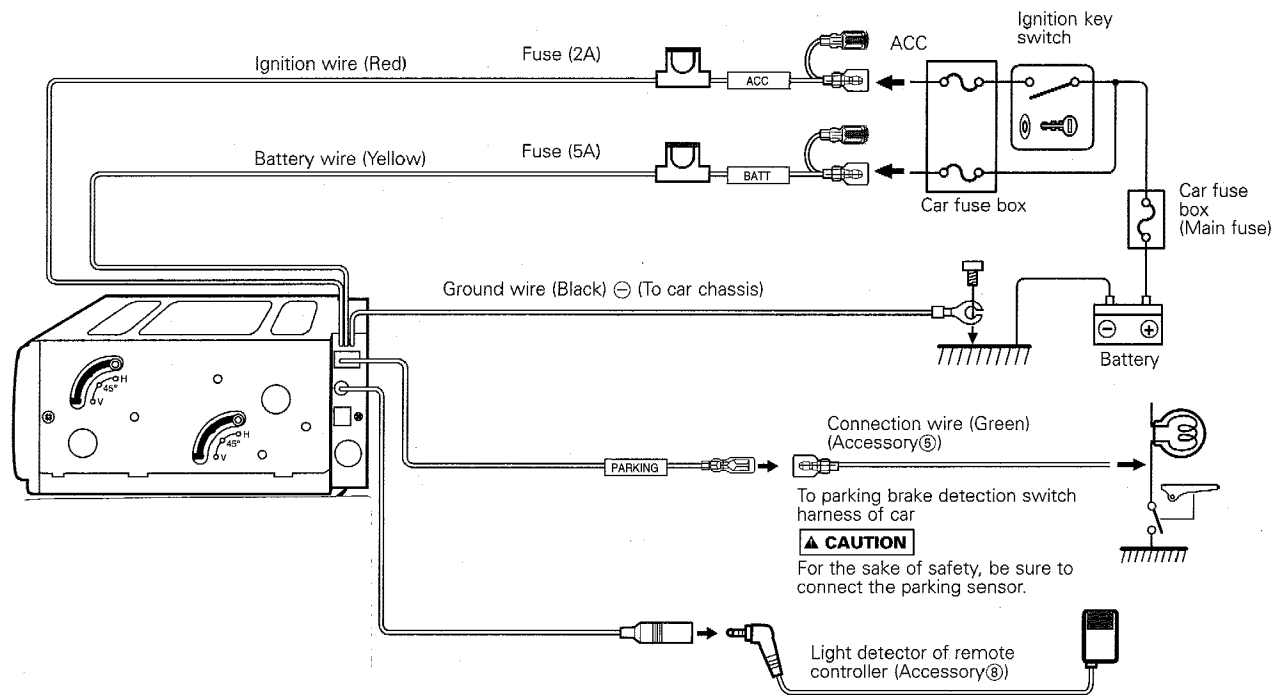

■ **To connect this unit to a monitor unit for use solely**

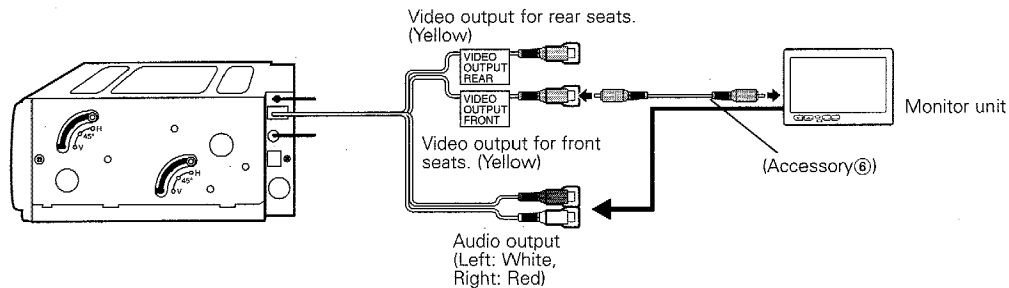

■ **When your car audio is Kenwood center unit**

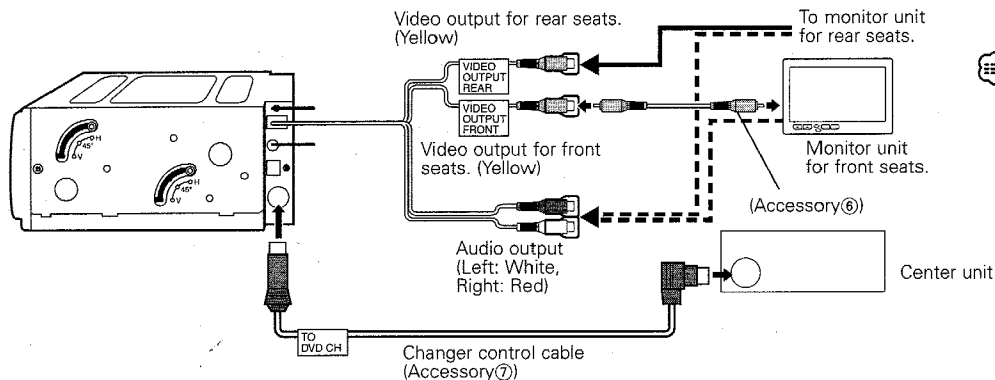

When the source mode of this unit is not selected in the center unit, you can use this unit solely.

Connecting Wires to Terminals

■ When your car audio has RCA input

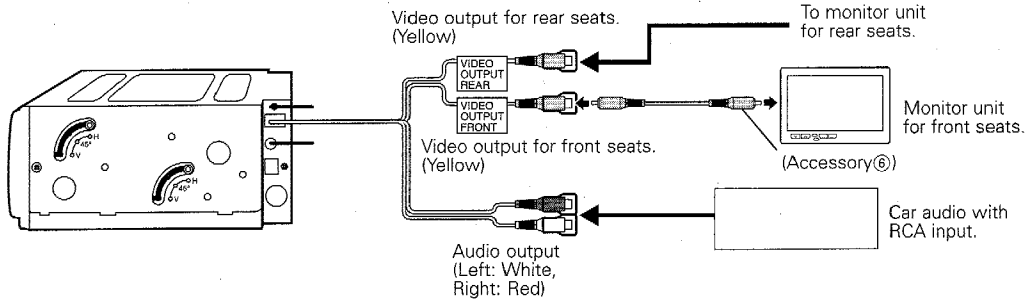

■ This is used to connect to a digital audio device

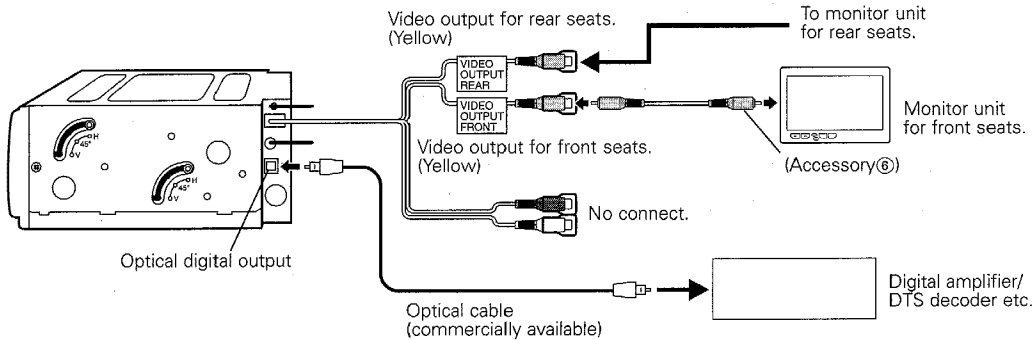

☞ Set "AUDIO OUT" depending on digital equipment to be connected. (See page 23)

Installation

■ Removing the transportation screws

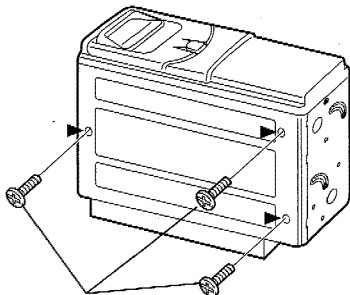

Transportation screws

Remove all 3 transportation screws for protecting the internal mechanism before you start to install the unit.

After removing the transport screw, retain it carefully and attach it again before transporting the unit again.

Cover the holes indicated by "▶" with the dustproof seals ①.

■ Angle adjustment switches

Horizontal installation

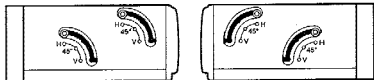

Vertical installation

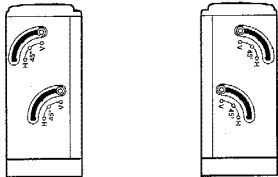

At a 45° angle

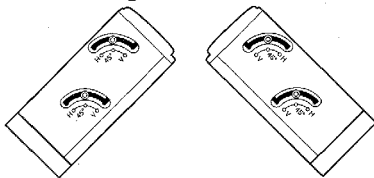

The angle adjustment switches on the both side of the unit are to be set according to the angle of installation of the DVD/CD auto changer. Set both of the 4 switches to the same position. If the switches are not set properly, sound skip or other malfunction may occur.

■ Horizontal installation

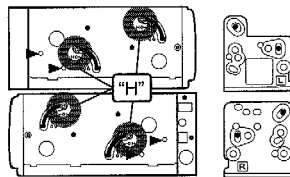

Set "H" for all the four angle adjustment parts on both sides. Cover the holes indicated by "▶"/"○" with the dustproof seals ①, ②. Use the holes marked "●" to install the unit.

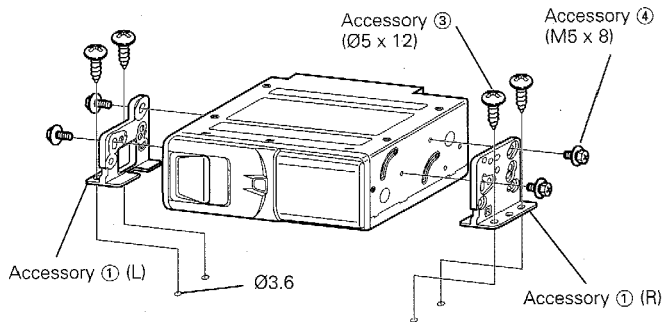

Installation

■ Vertical installation

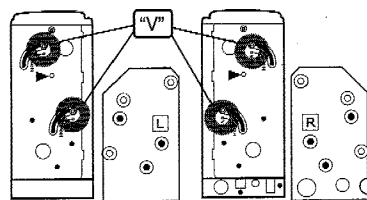

Set "V" for all the four angle adjustment parts on both sides.
Cover the holes indicated by "▶"/"○" with the dustproof seals ①, ②.
Use the holes marked "●" to install the unit.

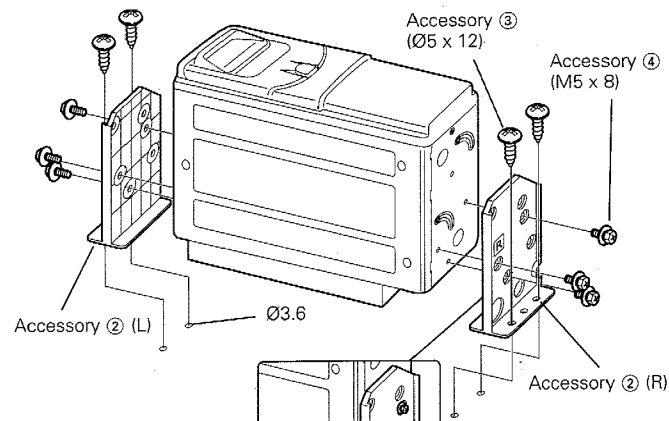

<When your car audio is Kenwood center unit>

Changer control cable
(Accessory 7)

■ At a 45° angle installation

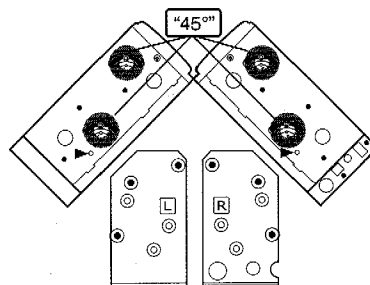

Set "45°" for all the four angle adjustment parts on both sides.
Cover the holes indicated by "▶"/"○" with the dustproof seals ①, ②.
Use the holes marked "●" to install the unit.

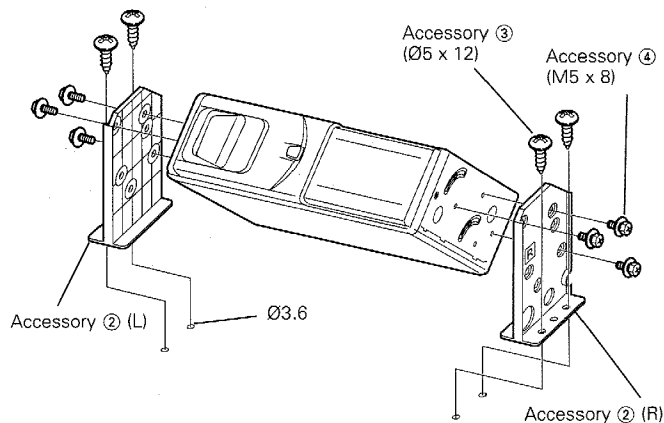

■ In case of hanging in the trunk

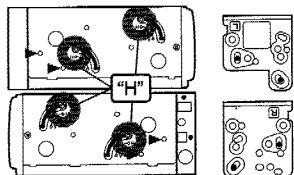

Set "H" for all the four angle adjustment parts on both sides. Cover the holes indicated by "▶"/"○" with the dustproof seals ⑪, ⑫. Use the holes marked "●" to install the unit.

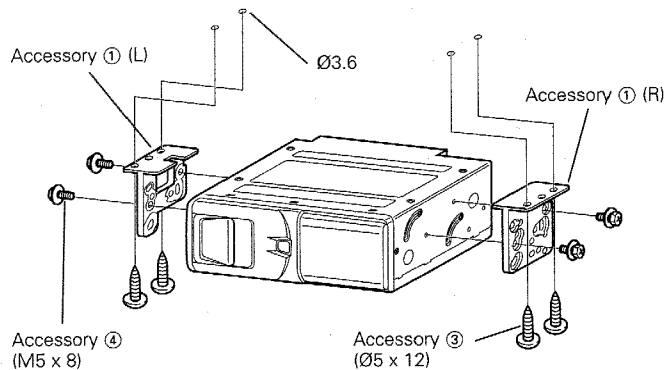

■ Mounting the remote controller

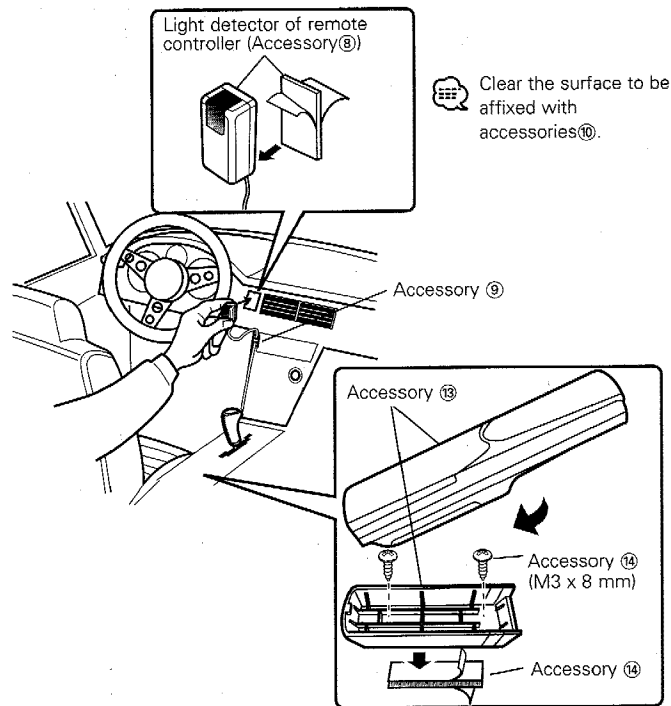

Troubleshooting Guide

What might seem to be a malfunction in your unit may just be the result of slight misoperation or miswiring. Before calling service, first check the following table for possible problems.

? The power does not turn ON.

- ✓ The fuse has blown.
 - ☞ After checking for short circuits in the wires, replace the fuse with one with the same rating.
- ✓ No ACC position on vehicle ignition.
 - ☞ Connect the same wire to the ignition as the battery wire.
- ✓ The remote controller does not work.
 - ☞ See <Connecting Wires to Terminals> (page 30) to connect the light detector of the remote controller correctly.

? The power cannot be turned off

- ✓ You select the source mode of this machine, which is connected to a center unit.
 - ☞ The power cannot be turned off because the center unit is under operation. If changing a mode other than the source mode of this machine on the center unit, you can turn off the power.

? The power is automatically turned off.

- ✓ You switched the source mode while connecting to a center unit.
 - ☞ If selecting the source mode of this machine on the center unit and then switching to a mode other than this machine, you can turn off the power.

? No video image appears.

- ✓ The unit is not connected to the parking brake detection switch.
 - ☞ Make proper connections according to <Connecting Wires to Terminals>.
- ✓ The parking brake is not engaged.
 - ☞ For safety reasons no video images are displayed while the vehicle is moving. Engaging the parking brake will cause images to be displayed.

? Nothing happens when the buttons are pressed.

- ✓ The "⊗" symbol appears in the screen.
 - ☞ You cannot carry out any operation disabled by disc.
- ✓ The batteries of the remote controller are weak.

- ☞ Replace both two batteries of the remote controller with new ones.

- ✓ The remote controller does not work.
 - ☞ See <Connecting Wires to Terminals> to connect the light detector of the remote controller correctly.
- ✓ A center unit not applicable is connected.
 - ☞ See <IMPORTANT INFORMATION> (page 4).

? The memory is erased when the ignition is turned OFF.

- ✓ The battery wire has not been connected to the proper terminal.
 - ☞ Connect the wire correctly, referring to the section on <Connecting Wires to Terminals>.
- ✓ The ignition and battery wire are incorrectly connected.
 - ☞ Connect the wire correctly, referring to the section on <Connecting Wires to Terminals>.

? No sound can be heard, or the volume is low.

- ✓ The audio setting of audio output is not "ANALOG".
 - ☞ If connecting through a center unit or RCA cable, select "ANALOG" for this setting.
- ✓ The input/output wires or wiring harness are connected incorrectly.
 - ☞ Reconnect the input/output wires or the wiring harness correctly. See the section on <Connecting Wires to Terminals>.

? The specified disc does not play, but another one plays instead.

- ✓ The specified DVD/CD is quite dirty.
 - ☞ Clean the Disc.
- ✓ The disc is upside down.
 - ☞ Set the disc with the label face downward.
- ✓ The disc is severely scratched.
 - ☞ Try another disc instead.

? The specified track will not play.

- ✓ Random play has been selected.
 - ☞ Turn off random play.

? Cannot play CD-R or CD-RW.

- ✓ Finalization processing is not being conducted for CD-R/CD-RW.
 - ☞ Conduct finalization processing with CD recorder.

? A VCD cannot be played using menus.

- ✓ The VCD disc being played is not compatible with P.B.C.
 - ☞ Menu playback is available only with VCD discs recorded with P.B.C.

? **The subtitle is not displayed.**

- ✓ The DVD disc being played does not contain the recording of subtitles.
 - ☞ The subtitle cannot be displayed when the DVD disc being played does not contain the recording of subtitles.

? **The voice (or subtitle) language cannot be changed.**

- ✓ The DVD disc being played does not contain the recording of more than one audio (or subtitle) language.
 - ☞ The voice (or subtitle) language cannot be changed when the DVD disc being played does not contain the recording of more than one voice (or subtitle) language.

? **The viewing angle cannot be changed.**

- ✓ The DVD disc being played does not contain the recording of more than one angle.
 - ☞ The viewing angle cannot be changed when the DVD disc being played does not contain the recording of more than one angle.
- ✓ You are attempting to switch the angle in a DVD section where more than one angle is not recorded.
 - ☞ More than one viewing angle may be recorded only in limited sections in a disc.

? **Playback will not start even after a title is selected.**

- ✓ A viewing restriction (RATING) has been set for the disc.
 - ☞ Check the viewing restriction level (RATING) setting.

? **The voice or subtitle language selected in the initial setting is not played.**

- ✓ The DVD disc being played does not contain the recording of the selected voice or subtitle language.
 - ☞ Use a DVD disc containing the recording of the selected voice or subtitle language.

MP3 source

? **Cannot play an MP3.**

- ✓ Not conforming to ISO 9660 Level 1/2, and Joliet.
 - ☞ Use a medium conforming to ISO 9660 Level 1/2, and Joliet.
- ✓ The MP3 has no or invalid track name extension.
 - ☞ Add the ".MP3" extension to the MP3 track name.
- ✓ The media is scratched or dirty.
 - ☞ Clean the media, referring to the section on <Disc cleaning> (page 6).

? **Noise or no sound generated when an MP3 is played.**

- ✓ The track has the MP3 track name extension while it is not an MP3.
 - ☞ Do not use the ".MP3" extension in non-MP3.

? **Takes time before the unit starts playing MP3.**

- ✓ The medium contains many albums, tracks, and hierarchical levels.
 - ☞ The unit checks all tracks on the loaded medium first. If the medium has many tracks recorded, it may take a long time for the unit before it starts playing MP3.

? **Fails to play MP3 in the intended order.**

- ✓ The MP3 tracks were not written by the CD writer in the order in which you wanted them to be played.
 - ☞ Depending on the CD writer, you may be able to set the order in which MP3 tracks are to be played by writing them onto a medium with their track names beginning with play sequence numbers such as "01" to "99".

? **The sound skips when an MP3 is being played.**

- ✓ The media is scratched or dirty.
 - ☞ Clean the media, referring to the section on <Disc cleaning> (page 6).
- ✓ The recording condition is bad.
 - ☞ Record the media again or use another media.

? **Can't enter Folder Select mode.**

- ✓ There's no folder recorded in the MP3 media.
 - ☞ Use a media with levels.

? **The songs in the selected folder aren't played in Folder Select mode.**





- ✓ There are no MP3 in the selected folder.
 - ☞ Make sure there's recorded content in the MP3 media.

? **The MP3 track/disc search takes time.**

- ✓ Many tracks are recorded on the media.
 - ☞ When the media directory is complex, the track/disc search can take time.

Troubleshooting Guide

The messages shown below display your systems condition.

- E-01:EJECT: No disc magazine has been loaded. The disc magazine is not completely loaded.
⇨ Load the disc magazine properly.
- NO DISC: No disc has been loaded in the disc magazine.
⇨ Load a disc into the disc magazine.
-  E-04: The Disc is quite dirty. The Disc is upside-down. The Disc is scratched a lot.
⇨ Clean the Disc and load it correctly.
-  E-15:
 - The disc cannot be played because of its unacceptable format.
 - A disc that cannot be read is set.⇨ Use another disc.
-  A file with unacceptable format is included.
- E-99: Something is wrong with the disc magazine. Or the unit is malfunctioning for some reason.
⇨ Check the disc magazine. And then press the reset button on the unit. If the "E-99" code does not disappear, consult your nearest service center.
- NO NAME: Attempted to display DNPS during the CD play having no disc names preset.
-  NO ACCESS: No playback has been performed after the disc was set into the disc changer.
- WRONG REGION!!!: The DVD software encoded for other region code.

Region codes in the world

The DVD players are given a region code according to the country or area it is marketed, as shown in the following map.

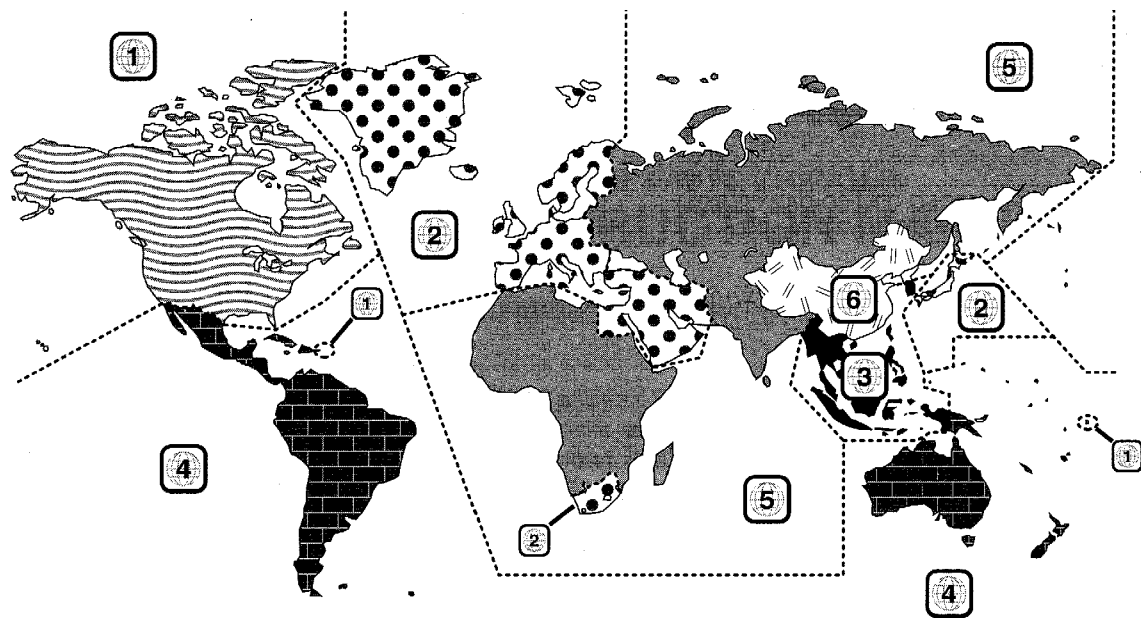

Specifications

Specifications subject to change without notice.

Player section

| | |
|---|---|
| D/A conversion | 8 Level $\Delta\Sigma$ |
| Wow and flutter | Below measurable limit |
| Frequency response (Sampling frequency; 96 kHz) | |
| | 20 Hz - 44 kHz |
| Total harmonic distortion | 0.01 % (1 kHz) |
| Signal to noise ratio | 110 dB |
| Dynamic range | 90 dB |
| Channel separation..... | 90 dB |
| Disc format | DVD-VIDEO / VIDEO CD / CD-DA / CD-ROM |
| MP3 decoder..... | Compliant with MPEG-1.0/2.0 Audio Layer-3 |

General

| | |
|--|---------------------------------|
| Audio output level / Load | 1.2 V/10 k Ω |
| Video output level | 1 V _{p-p} /75 Ω |
| Operating voltage (11 – 16V allowable) | 14.4 V |
| Current consumption..... | 3 A |
| Dimensions (W x H x D) | 250 x 80 x 200 mm |
| | 9-13/16 x 3-1/8 x 7-7/8 in. |
| Weight..... | 6.2 lbs (2.8 kg) |